

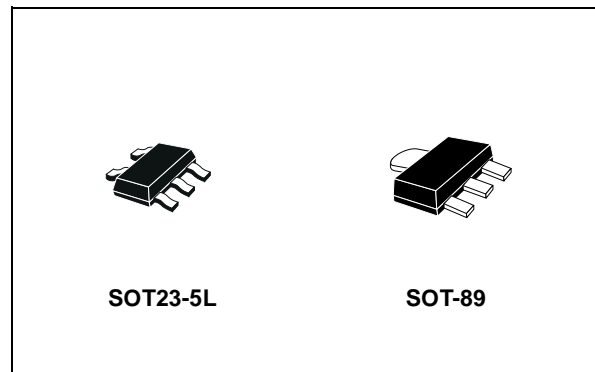


## ULTRA LOW DROP VOLTAGE REGULATORS WITH INHIBIT LOW ESR OUTPUT CAPACITORS COMPATIBLE

- STABLE WITH LOW ESR CERAMIC CAPACITORS
- ULTRA LOW DROPOUT VOLTAGE (0.12V TYP. AT 50mA LOAD, 7mV TYP. AT 1mA LOAD)
- VERY LOW QUIESCENT CURRENT (80 $\mu$ A TYP. AT NO LOAD IN ON MODE; MAX 1 $\mu$ A IN OFF MODE)
- GUARANTEED OUTPUT CURRENT UP TO 50mA
- LOGIC-CONTROLLED ELECTRONIC SHUTDOWN
- OUTPUT VOLTAGE OF 1.5; 1.8; 2.5; 2.85; 3.0; 3.2; 3.3; 3.6; 3.8; 4.0; 4.7; 4.85; 5.0V
- INTERNAL CURRENT AND THERMAL LIMIT
- $\pm 0.5\%$  TOLERANCE OUTPUT VOLTAGE AVAILABLE (A VERSION)
- OUTPUT LOW NOISE VOLTAGE 160 $\mu$ VRMS
- TEMPERATURE RANGE: -40 TO 125 $^{\circ}$ C
- SMALLEST PACKAGE SOT23-5L AND SOT-89
- FAST DYNAMIC RESPONSE TO LINE AND LOAD CHANGES

### DESCRIPTION

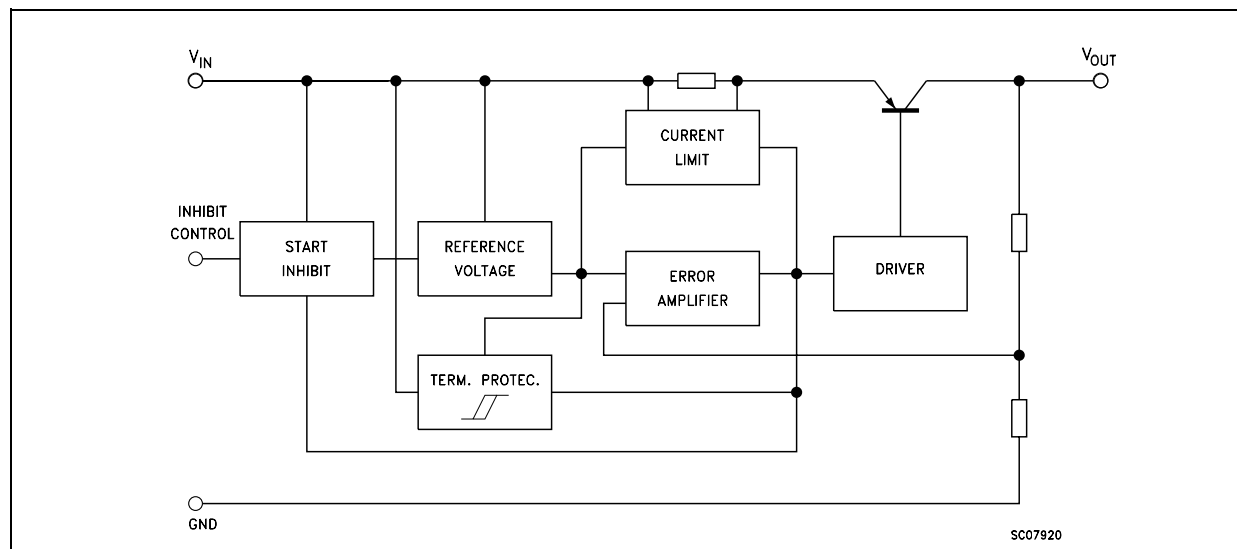
The LD2980 series are 50mA fixed-output voltage regulator. The low drop-voltage and the ultra low



quiescent current make them suitable for low noise, low power applications and in battery powered systems.

The quiescent current in sleep mode is less than 1 $\mu$ A when INHIBIT pin is pulled low. Shutdown Logic Control function is available on pin n.3 (TTL compatible). This means that when the device is used as local regulator, it is possible to put a part of the board in standby, decreasing the total power consumption. The LD2980 is designed to work with low ESR ceramic capacitor. Typical applications are in cellular phone, palmtop/laptop computer, personal digital assistant (PDA), personal stereo, camcorder and camera.

### SCHEMATIC DIAGRAM



## LD2980 SERIES

### ABSOLUTE MAXIMUM RATINGS

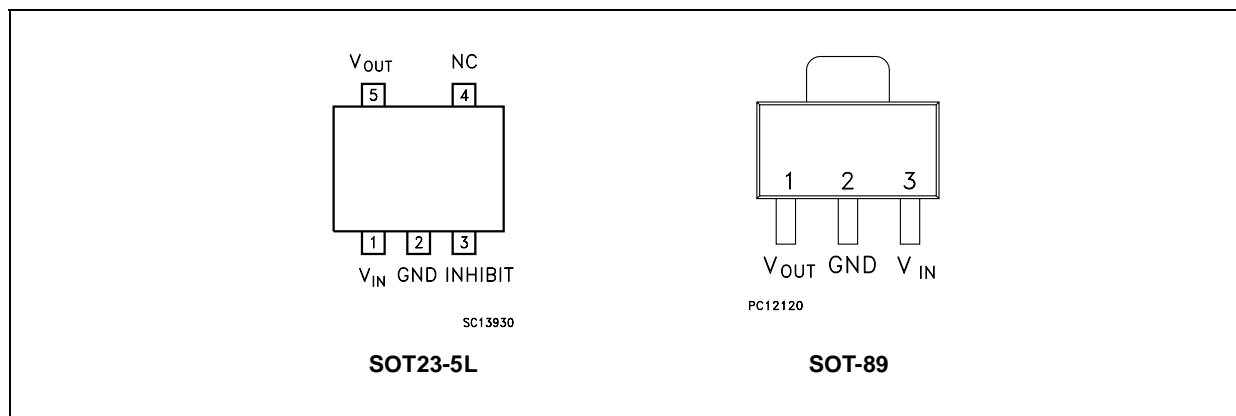
Symbol	Parameter	Value	Unit
$V_I$	DC Input Voltage	-0.3 to 16	V
$V_{INH}$	INHIBIT Input Voltage	-0.3 to 16	V
$I_O$	Output Current	Internally limited	
$P_D$	Power Dissipation	Internally limited	
$T_{STG}$	Storage Temperature Range	-55 to 150	°C
$T_{OP}$	Operating Junction Temperature Range	-40 to 125	°C

Absolute Maximum Ratings are those values beyond which damage to the device may occur. Functional operation under these condition is not implied.

### THERMAL DATA

Symbol	Parameter	SOT23-5L	SOT-89	Unit
$R_{thj-case}$	Thermal Resistance Junction-case	81	15	°C/W
$R_{thj-amb}$	Thermal Resistance Junction-ambient	255	110	°C/W

### CONNECTION DIAGRAM (top view)



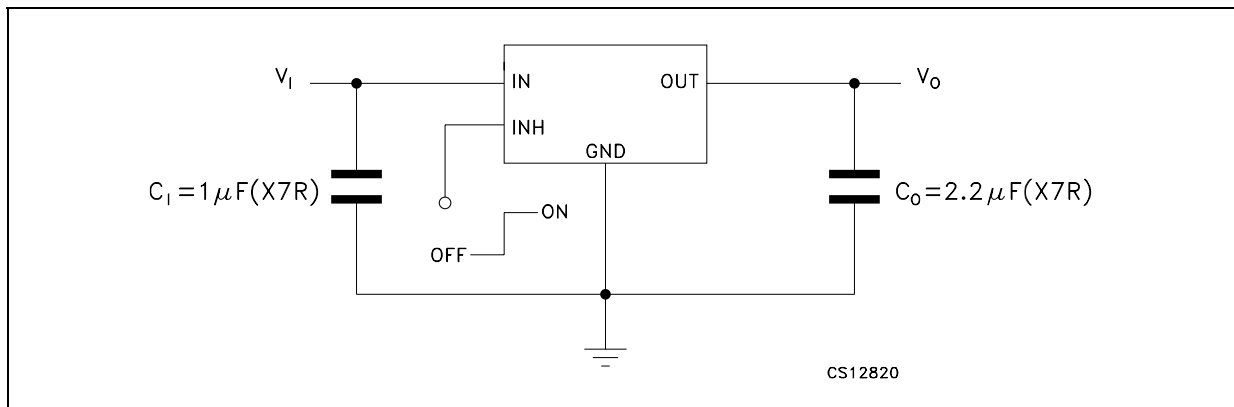
### PIN DESCRIPTION

Pin N° SOT23-5L	Pin N° SOT-89	Symbol	Name and Function
1	3	$V_{IN}$	Input Port
2	2	GND	Ground Pin
3		INHIBIT	Control switch ON/OFF. Inhibit is not internally pulled-up; it cannot be left floating. Disable the device when connected to GND or to a positive voltage less than 0.18V
4		NC	Not Connected
5	1	$V_{OUT}$	Output Port

ORDERING CODES

AB VERSION		C VERSION		OUTPUT VOLTAGES
SOT23-5L	SOT-89	SOT23-5L	SOT-89	
LD2980ABM15TR	LD2980ABU15TR	LD2980CM15TR	LD2980CU15TR	1.5 V
LD2980ABM18TR	LD2980ABU18TR	LD2980CM18TR	LD2980CU18TR	1.8 V
LD2980ABM25TR	LD2980ABU25TR	LD2980CM25TR	LD2980CU25TR	2.5 V
LD2980ABM28TR	LD2980ABU28TR	LD2980CM28TR	LD2980CU28TR	2.85 V
LD2980ABM30TR	LD2980ABU30TR	LD2980CM30TR	LD2980CU30TR	3.0 V
LD2980ABM32TR	LD2980ABU32TR	LD2980CM32TR	LD2980CU32TR	3.2 V
LD2980ABM33TR	LD2980ABU33TR	LD2980CM33TR	LD2980CU33TR	3.3 V
LD2980ABM36TR	LD2980ABU36TR	LD2980CM36TR	LD2980CU36TR	3.6 V
LD2980ABM38TR	LD2980ABU38TR	LD2980CM38TR	LD2980CU38TR	3.8 V
LD2980ABM40TR	LD2980ABU40TR	LD2980CM40TR	LD2980CU40TR	4.0 V
LD2980ABM47TR	LD2980ABU47TR	LD2980CM47TR	LD2980CU47TR	4.7 V
LD2980ABM48TR	LD2980ABU48TR	LD2980CM48TR	LD2980CU48TR	4.85 V
LD2980ABM50TR	LD2980ABU50TR	LD2980CM50TR	LD2980CU50TR	5.0 V

TYPICAL APPLICATION CIRCUIT



(\*) Inhibit Pin is not internally pulled-up then it must not be left floating. Disable the device when connected to GND or to a positive voltage less than 0.18V.

## LD2980 SERIES

**ELECTRICAL CHARACTERISTICS FOR LD2980AB** ( $T_j = 25^\circ\text{C}$ ,  $V_I = V_{O(\text{NOM})} + 1\text{V}$ ,  $C_I = 1\mu\text{F}(X7\text{R})$ ,  $C_O = 2.2\mu\text{F}(X7\text{R})$ ,  $I_O = 1\text{mA}$ ,  $V_{\text{INH}} = 2\text{V}$ , unless otherwise specified)

Symbol	Parameter	Test Conditions	Min.	Typ.	Max.	Unit
$V_{\text{OP}}$	Operating Input Voltage		2.5		16	V
$V_O$	Output Voltage	$I_O = 1\text{ mA}$	1.492	1.5	1.508	V
		$I_O = 1\text{ to }50\text{ mA}$	1.489		1.511	
		$I_O = 1\text{ to }50\text{ mA}$ $T_J = -40\text{ to }125^\circ\text{C}$	1.462		1.538	
$V_O$	Output Voltage	$I_O = 1\text{ mA}$	1.791	1.8	1.809	V
		$I_O = 1\text{ to }50\text{ mA}$	1.786		1.814	
		$I_O = 1\text{ to }50\text{ mA}$ $T_J = -40\text{ to }125^\circ\text{C}$	1.755		1.845	
$V_O$	Output Voltage	$I_O = 1\text{ mA}$	2.487	2.5	2.513	V
		$I_O = 1\text{ to }50\text{ mA}$	2.481		2.519	
		$I_O = 1\text{ to }50\text{ mA}$ $T_J = -40\text{ to }125^\circ\text{C}$	2.437		2.562	
$V_O$	Output Voltage	$I_O = 1\text{ mA}$	2.835	2.85	2.864	V
		$I_O = 1\text{ to }50\text{ mA}$	2.828		2.871	
		$I_O = 1\text{ to }50\text{ mA}$ $T_J = -40\text{ to }125^\circ\text{C}$	2.779		2.921	
$V_O$	Output Voltage	$I_O = 1\text{ mA}$	2.985	3	3.015	V
		$I_O = 1\text{ to }50\text{ mA}$	2.978		3.023	
		$I_O = 1\text{ to }50\text{ mA}$ $T_J = -40\text{ to }125^\circ\text{C}$	2.925		3.075	
$V_O$	Output Voltage	$I_O = 1\text{ mA}$	3.184	3.2	3.216	V
		$I_O = 1\text{ to }50\text{ mA}$	3.176		3.224	
		$I_O = 1\text{ to }50\text{ mA}$ $T_J = -40\text{ to }125^\circ\text{C}$	3.12		3.28	
$V_O$	Output Voltage	$I_O = 1\text{ mA}$	3.284	3.3	3.317	V
		$I_O = 1\text{ to }50\text{ mA}$	3.275		3.325	
		$I_O = 1\text{ to }50\text{ mA}$ $T_J = -40\text{ to }125^\circ\text{C}$	3.217		3.383	
$V_O$	Output Voltage	$I_O = 1\text{ mA}$	3.582	3.6	3.618	V
		$I_O = 1\text{ to }50\text{ mA}$	3.573		3.627	
		$I_O = 1\text{ to }50\text{ mA}$ $T_J = -40\text{ to }125^\circ\text{C}$	3.51		3.690	
$V_O$	Output Voltage	$I_O = 1\text{ mA}$	3.781	3.8	3.819	V
		$I_O = 1\text{ to }50\text{ mA}$	3.772		3.829	
		$I_O = 1\text{ to }50\text{ mA}$ $T_J = -40\text{ to }125^\circ\text{C}$	3.705		3.895	
$V_O$	Output Voltage	$I_O = 1\text{ mA}$	3.98	4	4.02	V
		$I_O = 1\text{ to }50\text{ mA}$	3.97		4.03	
		$I_O = 1\text{ to }50\text{ mA}$ $T_J = -40\text{ to }125^\circ\text{C}$	3.9		4.1	
$V_O$	Output Voltage	$I_O = 1\text{ mA}$	4.677	4.7	4.724	V
		$I_O = 1\text{ to }50\text{ mA}$	4.665		4.735	
		$I_O = 1\text{ to }50\text{ mA}$ $T_J = -40\text{ to }125^\circ\text{C}$	4.582		4.818	
$V_O$	Output Voltage	$I_O = 1\text{ mA}$	4.826	4.85	4.874	V
		$I_O = 1\text{ to }50\text{ mA}$	4.814		4.886	
		$I_O = 1\text{ to }50\text{ mA}$ $T_J = -40\text{ to }125^\circ\text{C}$	4.729		4.971	
$V_O$	Output Voltage	$I_O = 1\text{ mA}$	4.975	5	5.025	V
		$I_O = 1\text{ to }50\text{ mA}$	4.963		5.038	
		$I_O = 1\text{ to }50\text{ mA}$ $T_J = -40\text{ to }125^\circ\text{C}$	4.875		5.125	

Symbol	Parameter	Test Conditions	Min.	Typ.	Max.	Unit
$\Delta V_O$	Line Regulation	$V_{O(NOM)} + 1 < V_{IN} < 16\text{ V}$ $I_O = 1\text{ mA}$		0.003	0.014	%V
		$T_J = -40\text{ to }125^\circ\text{C}$			0.032	
$I_Q$	Quiescent Current ON MODE	$I_O = 0$		80	100	$\mu\text{A}$
		$I_O = 0$ $T_J = -40\text{ to }125^\circ\text{C}$			150	
		$I_O = 1\text{ mA}$		100	150	
		$I_O = 1\text{ mA}$ $T_J = -40\text{ to }125^\circ\text{C}$			200	
		$I_O = 10\text{ mA}$		175	250	
		$I_O = 10\text{ mA}$ $T_J = -40\text{ to }125^\circ\text{C}$			450	
		$I_O = 50\text{ mA}$		500	700	
		$I_O = 50\text{ mA}$ $T_J = -40\text{ to }125^\circ\text{C}$			1200	
	OFF MODE	$V_{INH} < 0.18\text{ V}$		0		
		$V_{INH} < 0.18\text{ V}$ $T_J = -40\text{ to }125^\circ\text{C}$				1
$V_{DROP}$	Dropout Voltage (NOTE 1)	$I_O = 0$		1	3	mV
		$I_O = 0$ $T_J = -40\text{ to }125^\circ\text{C}$			5	
		$I_O = 1\text{ mA}$		7	10	
		$I_O = 1\text{ mA}$ $T_J = -40\text{ to }125^\circ\text{C}$			15	
		$I_O = 10\text{ mA}$		40	60	
		$I_O = 10\text{ mA}$ $T_J = -40\text{ to }125^\circ\text{C}$			90	
		$I_O = 50\text{ mA}$		120	150	
		$I_O = 50\text{ mA}$ $T_J = -40\text{ to }125^\circ\text{C}$			225	
$I_{SC}$	Short Circuit Current	$R_L = 0$	150	300		mA
SVR	Supply Voltage Rejection	$C_O = 10\mu\text{F}$ $f = 1\text{ KHz}$		63		dB
$V_{INH}$	Inhibit Input Logic Low	LOW = Output OFF $T_J = -40\text{ to }125^\circ\text{C}$		0.8	0.18	V
$V_{INL}$	Inhibit Input Logic High	HIGH = Output ON $T_J = -40\text{ to }125^\circ\text{C}$	1.6	1.3		V
$I_{INH}$	Inhibit Input Current	$V_{INH} = 0\text{ V}$ $T_J = -40\text{ to }125^\circ\text{C}$		0	-1	$\mu\text{A}$
		$V_{INH} = 5\text{ V}$ $T_J = -40\text{ to }125^\circ\text{C}$		5	15	
$e_N$	Output Noise Voltage	$B_W = 300\text{ Hz to }50\text{ KHz}$ $C_O = 10\mu\text{F}$		160		$\mu\text{V}_{RMS}$
$T_{SHDN}$	Thermal Shutdown			170		$^\circ\text{C}$

(NOTE 1): For  $V_O < 2.5\text{V}$  dropout voltage can be calculated according to the minimum input voltage in full temperature range.

## LD2980 SERIES

**ELECTRICAL CHARACTERISTICS FOR LD2980C** ( $T_J = 25^\circ\text{C}$ ,  $V_I = V_{O(\text{NOM})} + 1\text{V}$ ,  $C_I = 1\mu\text{F(X7R)}$ ,  $C_O = 2.2\mu\text{F(X7R)}$ ,  $I_O = 1\text{mA}$ ,  $V_{\text{INH}} = 2\text{V}$ , unless otherwise specified)

Symbol	Parameter	Test Conditions	Min.	Typ.	Max.	Unit
$V_{\text{OP}}$	Operating Input Voltage		2.5		16	V
$V_O$	Output Voltage	$I_O = 1\text{ mA}$	1.485	1.5	1.515	V
		$I_O = 1\text{ to }50\text{ mA}$	1.477		1.523	
		$I_O = 1\text{ to }50\text{ mA}$ $T_J = -40\text{ to }125^\circ\text{C}$	1.447		1.553	
$V_O$	Output Voltage	$I_O = 1\text{ mA}$	1.782	1.8	1.818	V
		$I_O = 1\text{ to }50\text{ mA}$	1.773		1.827	
		$I_O = 1\text{ to }50\text{ mA}$ $T_J = -40\text{ to }125^\circ\text{C}$	1.737		1.863	
$V_O$	Output Voltage	$I_O = 1\text{ mA}$	2.475	2.5	2.525	V
		$I_O = 1\text{ to }50\text{ mA}$	2.463		2.538	
		$I_O = 1\text{ to }50\text{ mA}$ $T_J = -40\text{ to }125^\circ\text{C}$	2.412		2.587	
$V_O$	Output Voltage	$I_O = 1\text{ mA}$	2.822	2.85	2.879	V
		$I_O = 1\text{ to }50\text{ mA}$	2.807		2.893	
		$I_O = 1\text{ to }50\text{ mA}$ $T_J = -40\text{ to }125^\circ\text{C}$	2.75		2.949	
$V_O$	Output Voltage	$I_O = 1\text{ mA}$	2.97	3	3.03	V
		$I_O = 1\text{ to }50\text{ mA}$	2.955		3.045	
		$I_O = 1\text{ to }50\text{ mA}$ $T_J = -40\text{ to }125^\circ\text{C}$	2.895		3.105	
$V_O$	Output Voltage	$I_O = 1\text{ mA}$	3.168	3.2	3.232	V
		$I_O = 1\text{ to }50\text{ mA}$	3.152		3.248	
		$I_O = 1\text{ to }50\text{ mA}$ $T_J = -40\text{ to }125^\circ\text{C}$	3.088		3.312	
$V_O$	Output Voltage	$I_O = 1\text{ mA}$	3.267	3.3	3.333	V
		$I_O = 1\text{ to }50\text{ mA}$	3.251		3.35	
		$I_O = 1\text{ to }50\text{ mA}$ $T_J = -40\text{ to }125^\circ\text{C}$	3.184		3.415	
$V_O$	Output Voltage	$I_O = 1\text{ mA}$	3.564	3.6	3.636	V
		$I_O = 1\text{ to }50\text{ mA}$	3.546		3.654	
		$I_O = 1\text{ to }50\text{ mA}$ $T_J = -40\text{ to }125^\circ\text{C}$	3.474		3.726	
$V_O$	Output Voltage	$I_O = 1\text{ mA}$	3.76	3.8	3.838	V
		$I_O = 1\text{ to }50\text{ mA}$	3.743		3.857	
		$I_O = 1\text{ to }50\text{ mA}$ $T_J = -40\text{ to }125^\circ\text{C}$	3.667		3.933	
$V_O$	Output Voltage	$I_O = 1\text{ mA}$	3.96	4	4.04	V
		$I_O = 1\text{ to }50\text{ mA}$	3.94		4.06	
		$I_O = 1\text{ to }50\text{ mA}$ $T_J = -40\text{ to }125^\circ\text{C}$	3.86		4.14	
$V_O$	Output Voltage	$I_O = 1\text{ mA}$	4.653	4.7	4.747	V
		$I_O = 1\text{ to }50\text{ mA}$	4.630		4.771	
		$I_O = 1\text{ to }50\text{ mA}$ $T_J = -40\text{ to }125^\circ\text{C}$	4.535		4.864	
$V_O$	Output Voltage	$I_O = 1\text{ mA}$	4.802	4.85	4.899	V
		$I_O = 1\text{ to }50\text{ mA}$	4.777		4.923	
		$I_O = 1\text{ to }50\text{ mA}$ $T_J = -40\text{ to }125^\circ\text{C}$	4.68		5.02	
$V_O$	Output Voltage	$I_O = 1\text{ mA}$	4.95	5	5.05	V
		$I_O = 1\text{ to }50\text{ mA}$	4.925		5.075	
		$I_O = 1\text{ to }50\text{ mA}$ $T_J = -40\text{ to }125^\circ\text{C}$	4.825		5.175	

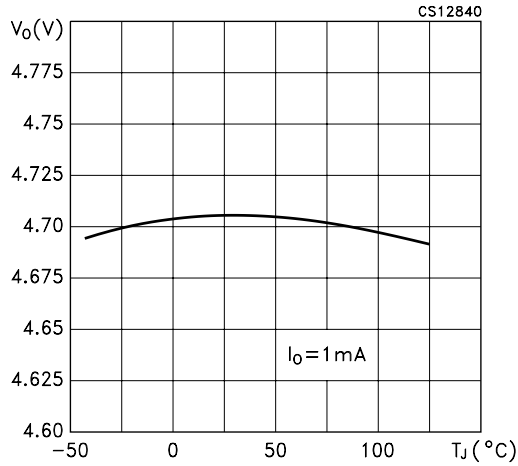
Symbol	Parameter	Test Conditions	Min.	Typ.	Max.	Unit
$\Delta V_O$	Line Regulation	$V_{O(NOM)} + 1 < V_{IN} < 16\text{ V}$ $I_O = 1\text{ mA}$		0.003	0.014	%V
		$T_J = -40\text{ to }125^\circ\text{C}$			0.032	
$I_Q$	Quiescent Current ON MODE	$I_O = 0$		80	100	$\mu\text{A}$
		$I_O = 0$ $T_J = -40\text{ to }125^\circ\text{C}$			150	
		$I_O = 1\text{ mA}$		100	150	
		$I_O = 1\text{ mA}$ $T_J = -40\text{ to }125^\circ\text{C}$			200	
		$I_O = 10\text{ mA}$		175	250	
		$I_O = 10\text{ mA}$ $T_J = -40\text{ to }125^\circ\text{C}$			450	
		$I_O = 50\text{ mA}$		500	700	
		$I_O = 50\text{ mA}$ $T_J = -40\text{ to }125^\circ\text{C}$			1200	
	OFF MODE	$V_{INH} < 0.18\text{ V}$		0		
		$V_{INH} < 0.18\text{ V}$ $T_J = -40\text{ to }125^\circ\text{C}$				1
$V_{DROP}$	Dropout Voltage (NOTE 1)	$I_O = 0$		1	3	mV
		$I_O = 0$ $T_J = -40\text{ to }125^\circ\text{C}$			5	
		$I_O = 1\text{ mA}$		7	10	
		$I_O = 1\text{ mA}$ $T_J = -40\text{ to }125^\circ\text{C}$			15	
		$I_O = 10\text{ mA}$		40	60	
		$I_O = 10\text{ mA}$ $T_J = -40\text{ to }125^\circ\text{C}$			90	
		$I_O = 50\text{ mA}$		120	150	
		$I_O = 50\text{ mA}$ $T_J = -40\text{ to }125^\circ\text{C}$			225	
$I_{SC}$	Short Circuit Current	$R_L = 0$	150	300		mA
SVR	Supply Voltage Rejection	$C_O = 10\mu\text{F}$ $f = 1\text{ KHz}$		63		dB
$V_{INH}$	Inhibit Input Logic Low	LOW = Output OFF $T_J = -40\text{ to }125^\circ\text{C}$		0.8	0.18	V
$V_{INL}$	Inhibit Input Logic High	HIGH = Output ON $T_J = -40\text{ to }125^\circ\text{C}$	1.6	1.3		V
$I_{INH}$	Inhibit Input Current	$V_{INH} = 0\text{ V}$ $T_J = -40\text{ to }125^\circ\text{C}$		0	-1	$\mu\text{A}$
		$V_{INH} = 5\text{ V}$ $T_J = -40\text{ to }125^\circ\text{C}$		5	15	
$e_N$	Output Noise Voltage	$B_W = 300\text{ Hz to }50\text{ KHz}$ $C_O = 10\mu\text{F}$		160		$\mu\text{V}_{RMS}$
$T_{SHDN}$	Thermal Shutdown			170		$^\circ\text{C}$

(NOTE 1): For  $V_O < 2.5\text{V}$  dropout voltage can be calculated according to the minimum input voltage in full temperature range.

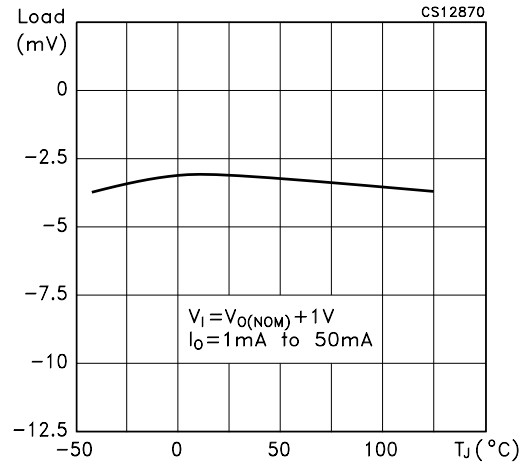
# LD2980 SERIES

**TYPICAL PERFORMANCE CHARACTERISTICS** ( $T_j = 25^\circ\text{C}$ ,  $V_I = V_{O(\text{NOM})} + 1\text{V}$ ,  $C_I = 1\mu\text{F}(\text{X7R})$ ,  $C_O = 2.2\mu\text{F}(\text{X7R})$ ,  $V_{\text{INH}} = 2\text{V}$ , unless otherwise specified)

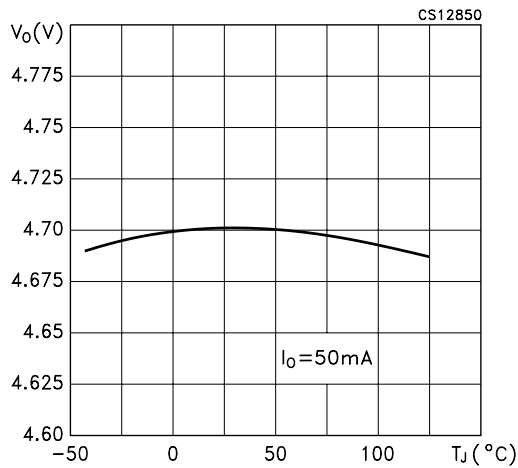
**Figure 1 : Output Voltage vs Temperature**



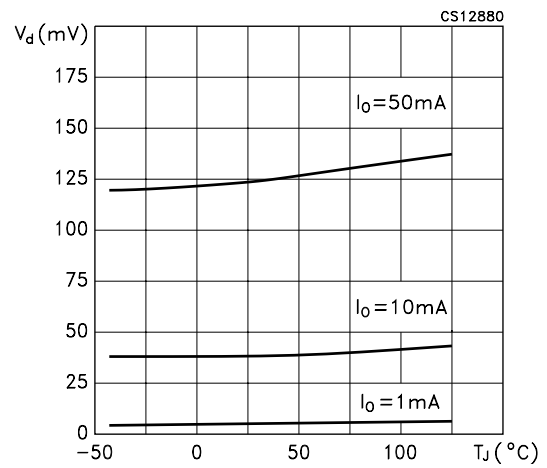
**Figure 4 : Load Regulation vs Temperature**



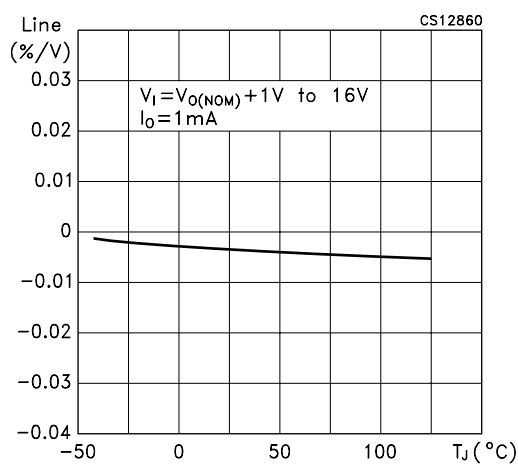
**Figure 2 : Output Voltage vs Temperature**



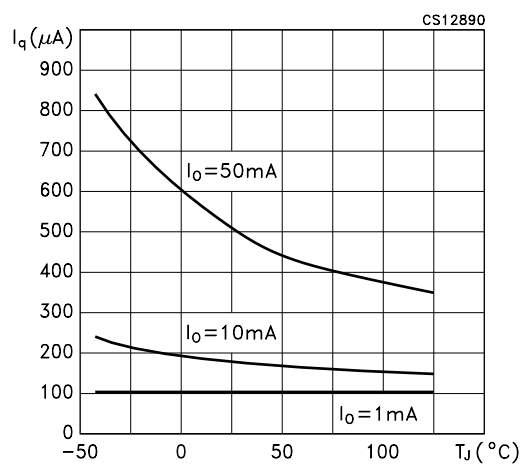
**Figure 5 : Dropout Voltage vs Temperature**



**Figure 3 : Line Regulation vs Temperature**

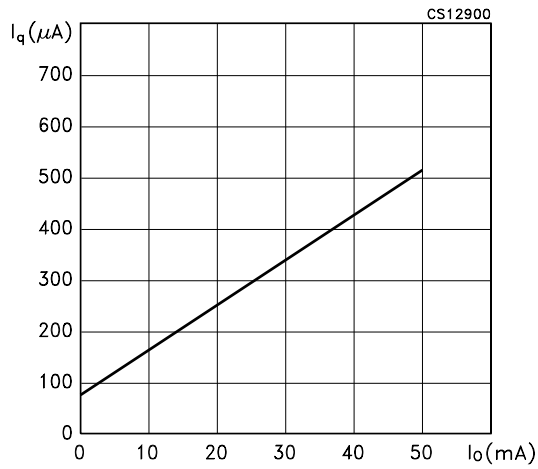


**Figure 6 : Quiescent Current vs Temperature**

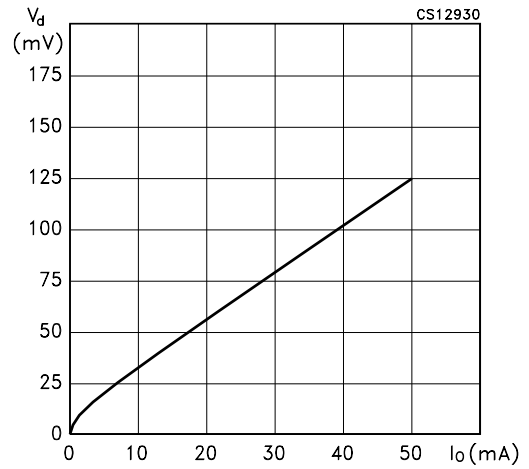




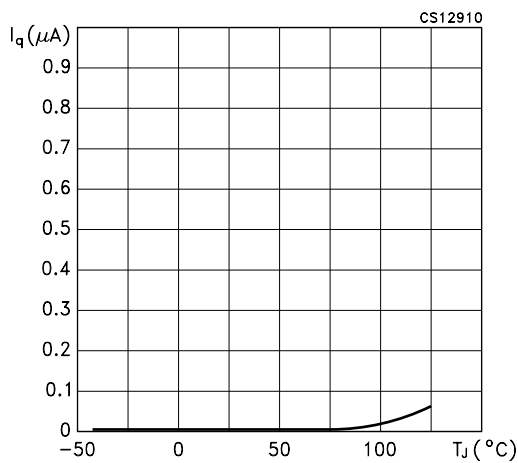
**Figure 7 : Quiescent Current vs Output Current**



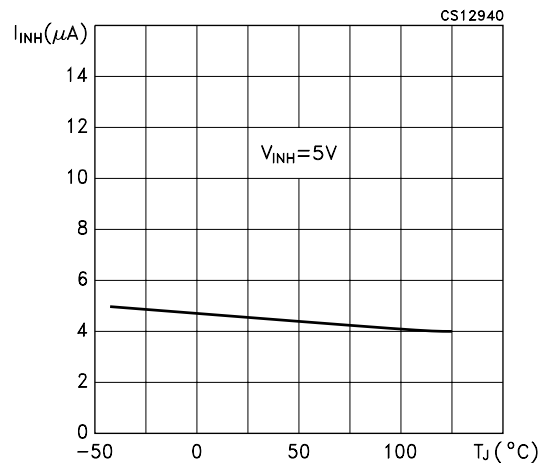
**Figure 10 : Dropout Voltage vs Output Current**



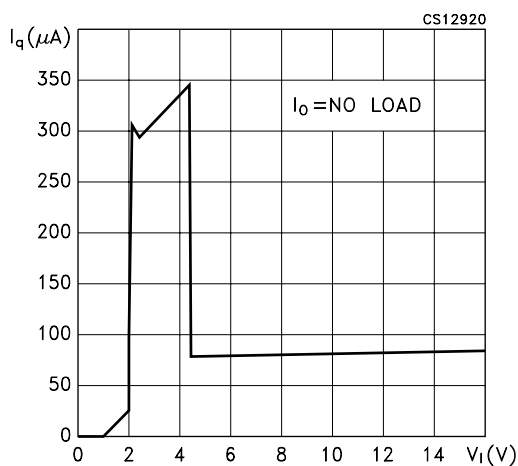
**Figure 8 : OFF MODE Quiescent Current vs Temperature**



**Figure 11 : Inhibit Input Current vs Temperature**



**Figure 9 : Quiescent Current vs Input Voltage**



**Figure 12 : Inhibit Voltage vs Temperature**

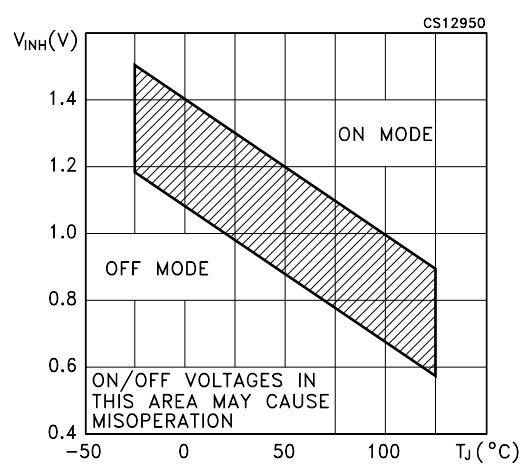


Figure 13 : Supply Voltage Rejection vs Frequency

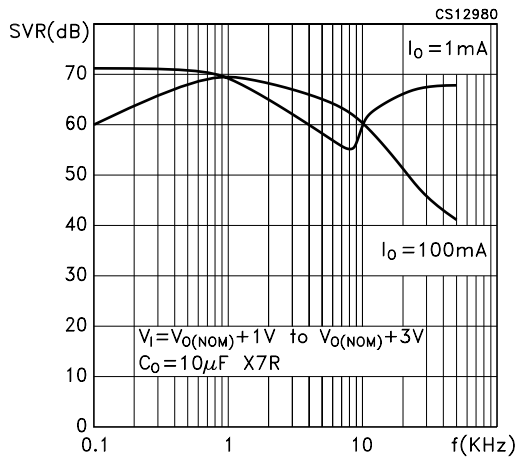


Figure 14 : Noise Voltage vs Frequency

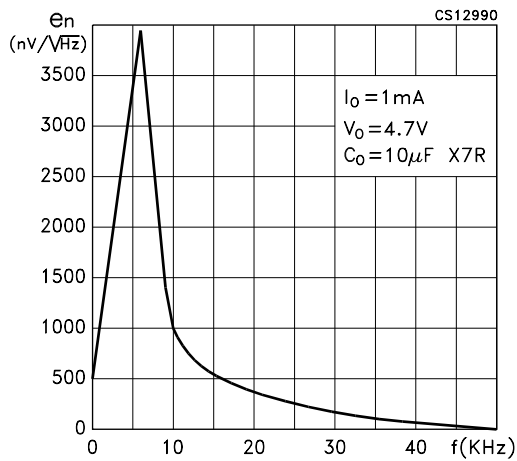


Figure 15 : Best Case: Highest Output Version

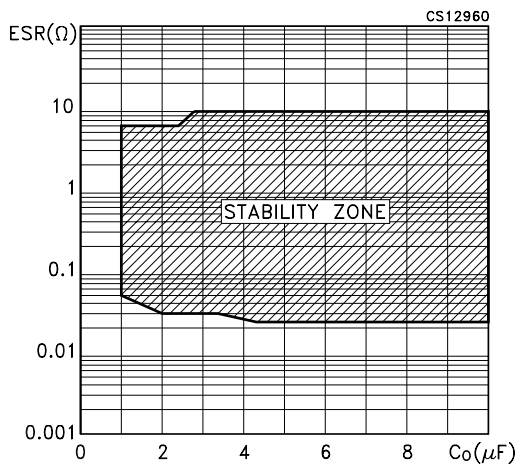


Figure 16 : Worst Case: Lowest Output Version

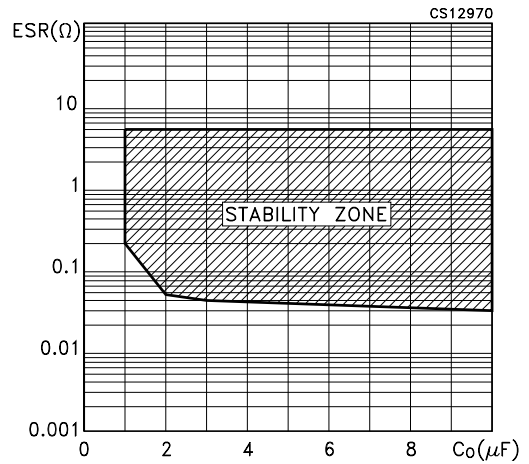


Figure 17 : Load Transient Response

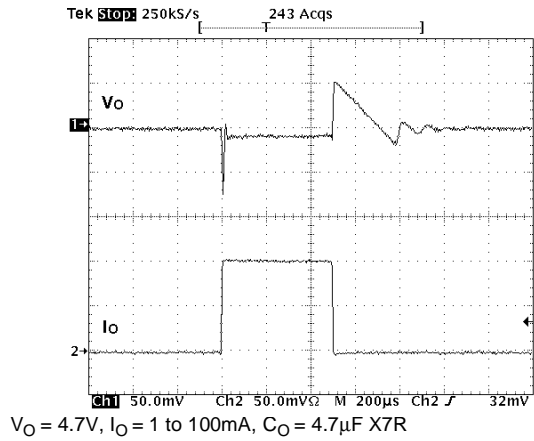
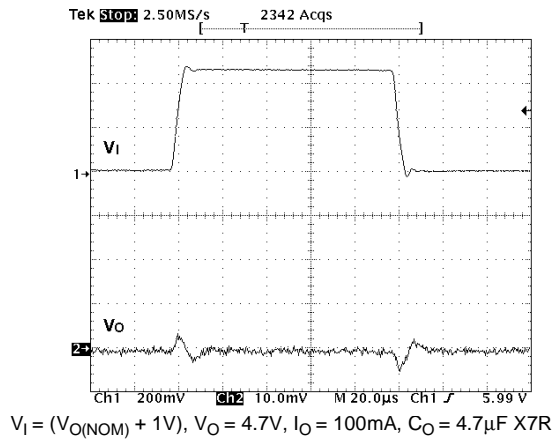


Figure 18 : Line Transient Response



## APPLICATION NOTES

### EXTERNAL CAPACITORS

Like any low-dropout regulator, the LD2980 requires external capacitors for regulator stability. This capacitor must be selected to meet the requirements of minimum capacitance and equivalent series resistance. We suggest to solder input and output capacitors as close as possible to the relative pins.

### INPUT CAPACITOR

An input capacitor whose value is  $1\mu\text{F}$  is required with the LD2980 (amount of capacitance can be increased without limit). This capacitor must be located a distance of not more than 0.5" from the input pin of the device and returned to a clean analog ground. Any good quality ceramic, tantalum or film capacitors can be used for this capacitor.

### OUTPUT CAPACITOR

The LD2980 is designed specifically to work with ceramic output capacitors. It may also be possible to use Tantalum capacitors, but these are not as attractive for reasons of size and cost. By the way, the output capacitor must meet both the requirement for minimum amount of capacitance and ESR (equivalent series resistance) value. The figures 1 and 2 show the allowable ESR range as a function of the output capacitance. These curves represent the stability region over the full temperature and  $I_O$  range. Due to the different loop gain, the stability improves for higher output versions and so the suggested minimum output capacitor value, if low ESR ceramic type is used, is  $1\mu\text{F}$  for output voltages equal or major than 3.8V,  $2.2\mu\text{F}$  for output voltages from 2.85 to 3.3V, and  $3.3\mu\text{F}$  for the other versions. However, if an output capacitor lower than the suggested one is used, it's possible to make stable the regulator adding a resistor in series to the capacitor (see Figure1 & Figure2 to choose the right value according to the used version and keeping in account that the ESR of ceramic capacitors has been measured @ 100KHz).

### IMPORTANT

The output capacitor must maintain its ESR in the stable region over the full operating temperature to assure stability. Also, capacitor tolerance and variation with temperature must be considered to assure the minimum amount of capacitance is provided at all times. This capacitor should be located not more than 0.5" from the output pin of the device and returned to a clean analog ground.

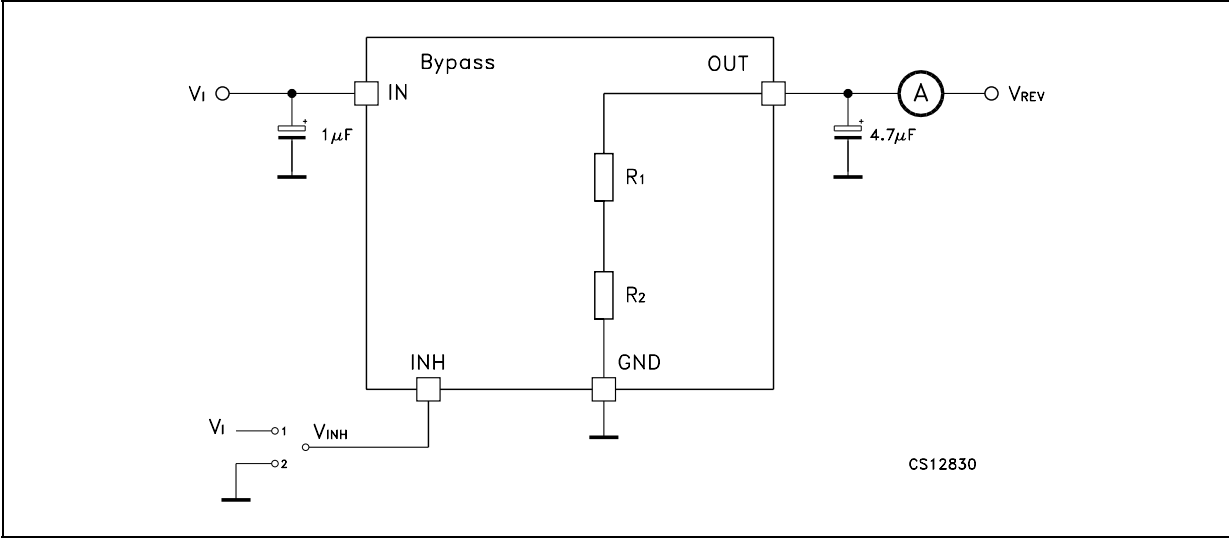
### INHIBIT INPUT OPERATION

The inhibit pin can be used to turn OFF the regulator when pulled low, so drastically reducing the current consumption down to less than  $1\mu\text{A}$ . When the inhibit feature is not used, this pin must be tied to  $V_I$  to keep the regulator output ON at all times. To assure proper operation, the signal source used to drive the inhibit pin must be able to swing above and below the specified thresholds listed in the electrical characteristics section under  $V_{IH}$   $V_{IL}$ . Any slew rate can be used to drive the inhibit.

### REVERSE CURRENT

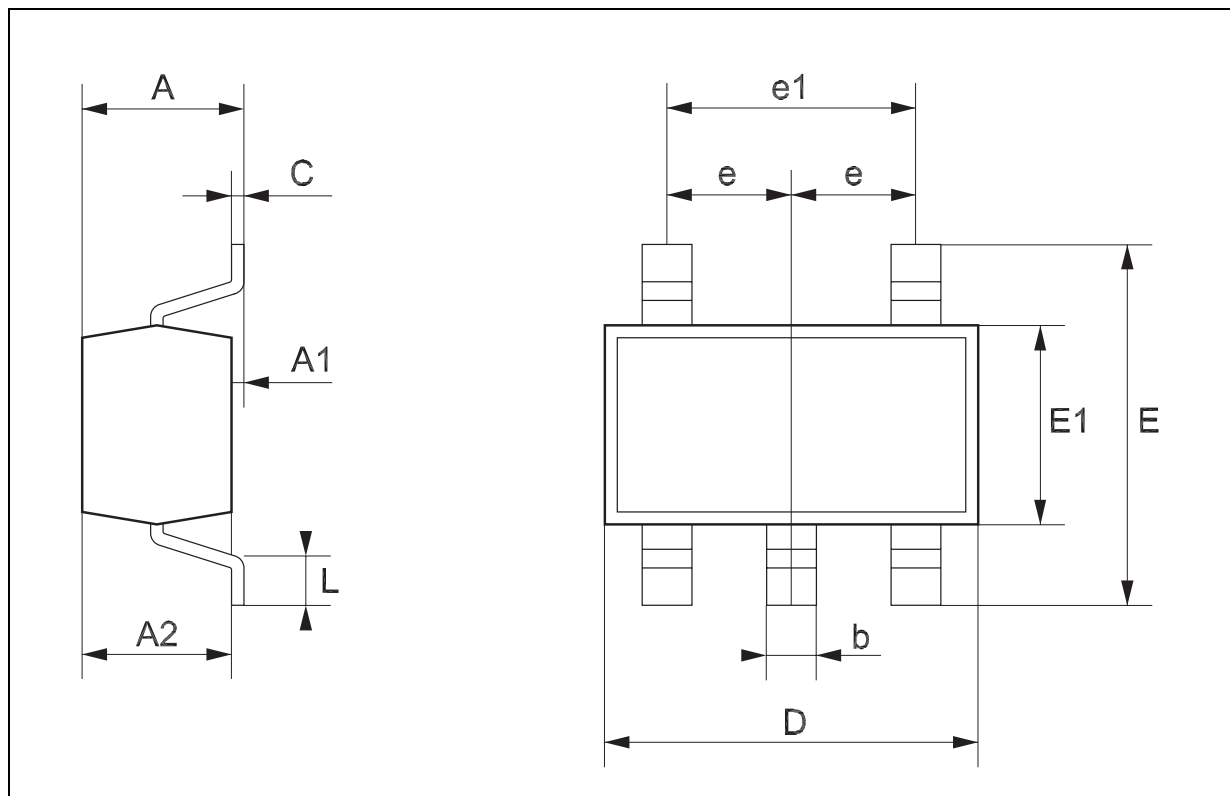
The power transistor used in the LD2980 has not an inherent diode connected between the regulator input and output. If the output is forced above the input, no current will flow from the output to the input across the series pass transistor. When a  $V_{REV}$  voltage is applied on the output, the reverse current measured, according to the test circuit in figure 19, flows to the GND across the two feedback resistors. This current typical value is  $160\mu\text{A}$ .  $R_1$  and  $R_2$  resistors are implanted type; typical values are, respectively,  $42.6\text{ K}\Omega$  and  $51.150\text{ K}\Omega$ .

Figure 19 : Reverse Current Test Circuit



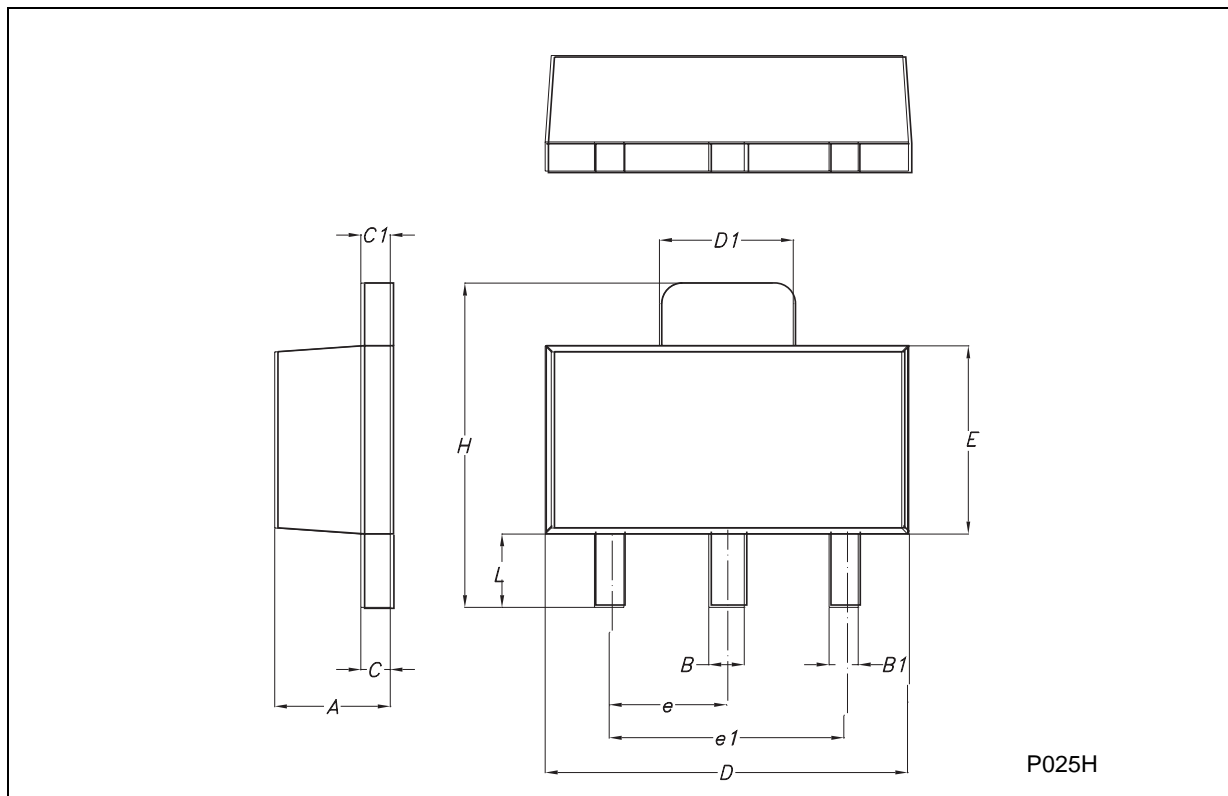
## SOT23-5L MECHANICAL DATA

DIM.	mm.			mils		
	MIN.	TYP	MAX.	MIN.	TYP.	MAX.
A	0.90		1.45	35.4		57.1
A1	0.00		0.15	0.0		5.9
A2	0.90		1.30	35.4		51.2
b	0.35		0.50	13.7		19.7
C	0.09		0.20	3.5		7.8
D	2.80		3.00	110.2		118.1
E	2.60		3.00	102.3		118.1
E1	1.50		1.75	59.0		68.8
e		0.95			37.4	
e1		1.9			74.8	
L	0.35		0.55	13.7		21.6



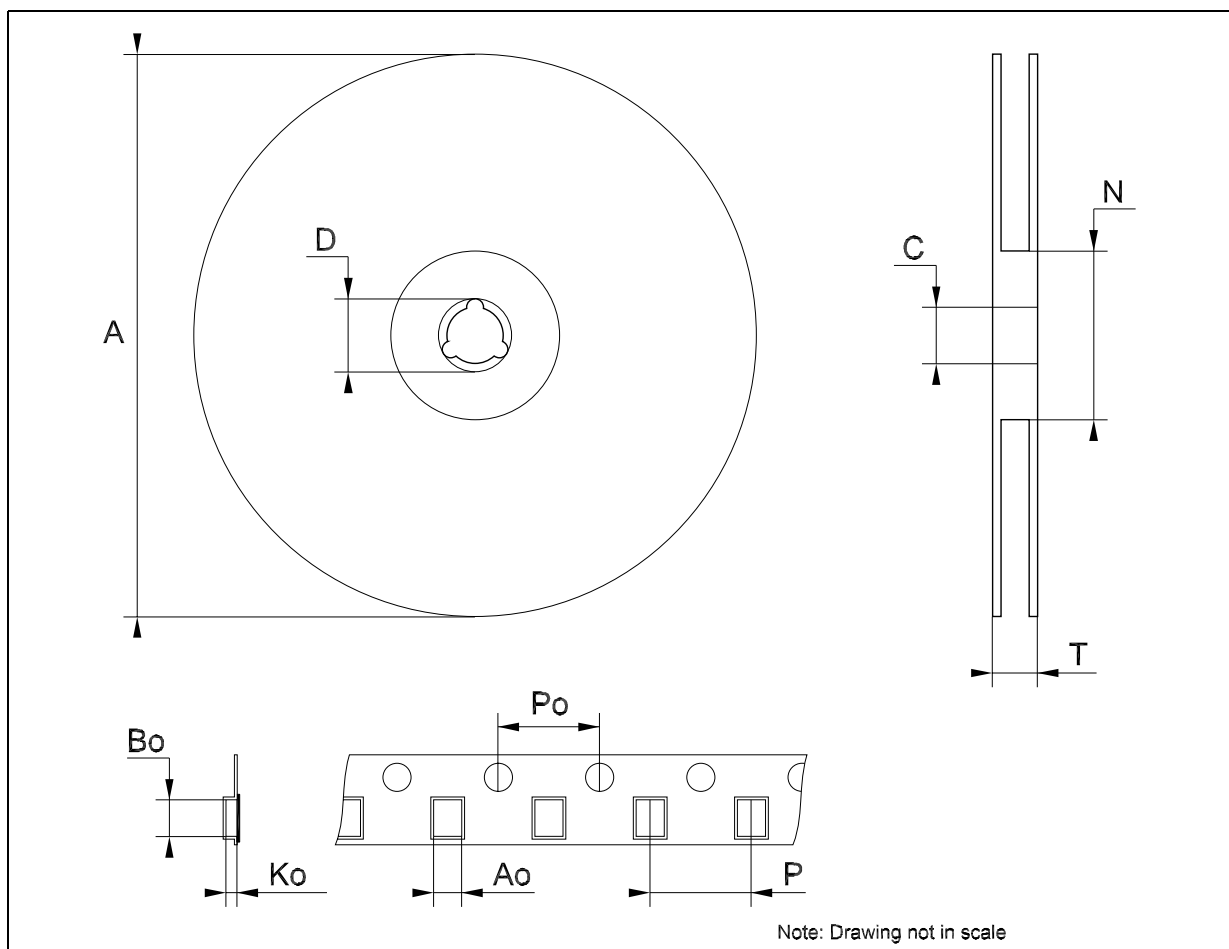
**SOT-89 MECHANICAL DATA**

DIM.	mm.			mils		
	MIN.	TYP	MAX.	MIN.	TYP.	MAX.
A	1.4		1.6	55.1		63.0
B	0.44		0.56	17.3		22.0
B1	0.36		0.48	14.2		18.9
C	0.35		0.44	13.8		17.3
C1	0.35		0.44	13.8		17.3
D	4.4		4.6	173.2		181.1
D1	1.62		1.83	63.8		72.0
E	2.29		2.6	90.2		102.4
e	1.42		1.57	55.9		61.8
e1	2.92		3.07	115.0		120.9
H	3.94		4.25	155.1		167.3
L	0.89		1.2	35.0		47.2



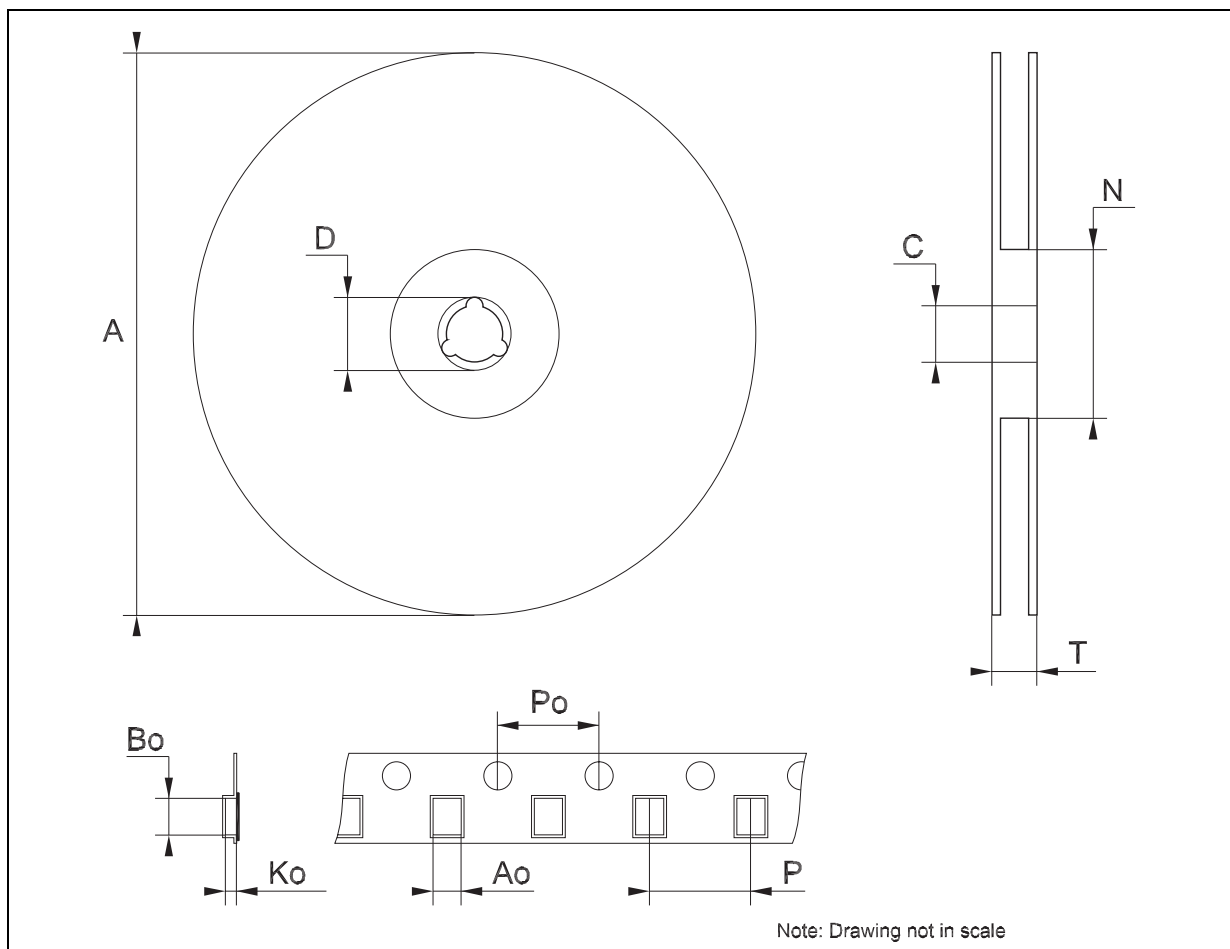
## Tape &amp; Reel SOT23-xL MECHANICAL DATA

DIM.	mm.			inch		
	MIN.	TYP	MAX.	MIN.	TYP.	MAX.
A			180			7.086
C	12.8	13.0	13.2	0.504	0.512	0.519
D	20.2			0.795		
N	60			2.362		
T			14.4			0.567
Ao	3.13	3.23	3.33	0.123	0.127	0.131
Bo	3.07	3.17	3.27	0.120	0.124	0.128
Ko	1.27	1.37	1.47	0.050	0.054	0.058
Po	3.9	4.0	4.1	0.153	0.157	0.161
P	3.9	4.0	4.1	0.153	0.157	0.161



**Tape & Reel SOT89 MECHANICAL DATA**

DIM.	mm.			inch		
	MIN.	TYP	MAX.	MIN.	TYP.	MAX.
A			180			7.086
C	12.8	13.0	13.2	0.504	0.512	0.519
D	20.2			0.795		
N	60			2.362		
T			14.4			0.567
Ao	4.70	4.80	4.90	0.185	0.189	0.193
Bo	4.30	4.40	4.50	0.169	0.173	0.177
Ko	1.70	1.80	1.90	0.067	0.071	0.075
Po	3.9	4.0	4.1	0.153	0.157	0.161
P	7.9	8.0	8.1	0.311	0.315	0.319





Information furnished is believed to be accurate and reliable. However, STMicroelectronics assumes no responsibility for the consequences of use of such information nor for any infringement of patents or other rights of third parties which may result from its use. No license is granted by implication or otherwise under any patent or patent rights of STMicroelectronics. Specifications mentioned in this publication are subject to change without notice. This publication supersedes and replaces all information previously supplied. STMicroelectronics products are not authorized for use as critical components in life support devices or systems without express written approval of STMicroelectronics.

© The ST logo is a registered trademark of STMicroelectronics

© 2003 STMicroelectronics - Printed in Italy - All Rights Reserved  
STMicroelectronics GROUP OF COMPANIES

Australia - Brazil - Canada - China - Finland - France - Germany - Hong Kong - India - Israel - Italy - Japan - Malaysia - Malta - Morocco  
Singapore - Spain - Sweden - Switzerland - United Kingdom - United States.

© <http://www.st.com>

